

联系我们

鹤壁海昌智能科技有限公司

地址：河南省鹤壁市经济技术开发区渤海路396号
邮编：458030
手机：186-3922-9550
电话：0392-3357155/6/9
邮箱：sales@hacint.com.cn
网址：http://www.hacint.com.cn/

河南海弘软件技术有限公司

地址：河南省鹤壁市经济技术开发区渤海路396号
邮编：458030
电话：155-6562-0606/186-0392-0258
邮箱：gaoxiangyang@hacint.com.cn

东莞海弘智能科技有限公司

地址：广东省东莞市松山湖大道和源丰南路交叉口
松湖智谷产业园D2栋5楼
邮编：523075
电话：166-3926-9813/186-0392-0258
传真：0392-3313264
邮箱：chengxiaoliang@hacint.com.cn

昆山海弘智能科技有限公司

地址：江苏省昆山市高新技术开发区长阳路68号
邮编：200083
电话：166-3926-9821/189-3929-1579
邮箱：wanghongwei@hacint.com.cn

长春技术服务中心

地址：长春市朝阳区光谷大街咖啡小镇52栋1单元401室
邮编：130012
电话：186-3921-6887
邮箱：zhuxinwei@hacint.com.cn

重庆技术服务中心

地址：重庆市北部新区翠渝路2号汽车工业配套园4区C栋3层5楼
邮编：401120
电话：166-3926-9812
邮箱：liuhuibiao@hacint.com.cn

亚洲营销服务

地址：河南省鹤壁市经济技术开发区渤海路396号
邮编：458030
电话：166-3926-9815
邮箱：mafei@hacint.com.cn

美洲营销服务

地址：河南省鹤壁市经济技术开发区渤海路396号
邮编：458030
电话：166-3926-9800
邮箱：wangxin@hacint.com.cn

欧洲营销服务

地址：河南省鹤壁市经济技术开发区渤海路396号
邮编：458030
电话：166-3926-9831
邮箱：liyuan2@hacint.com.cn

非洲营销服务

地址：河南省鹤壁市经济技术开发区渤海路396号
邮编：458030
电话：166-3926-9816
邮箱：yangjilong@hacint.com.cn

全球服务热线

400-666-9765



注：本样本内容均经过详细核实，因校对、拍摄及印刷原因所造成的失误应以实际为准，产品图片以实物为准，技术参数以产品说明为准。
样本内提到的其它产品、徽标及公司名称归各所有者。
郑州市深度设计有限公司提供设计印刷支持 电话：0371-55693696

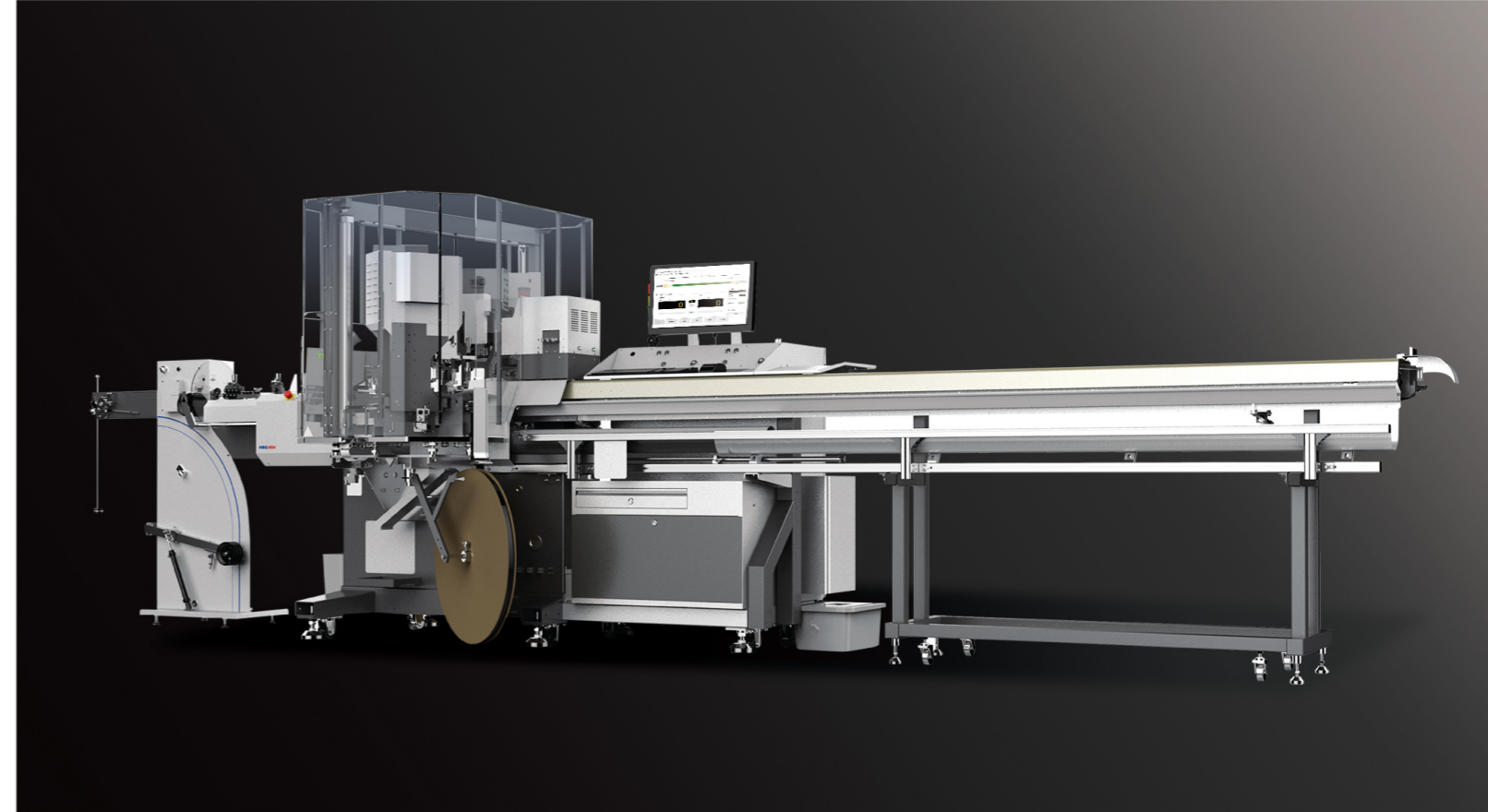

产品
型录

扫码输入设备型号
获取详细信息

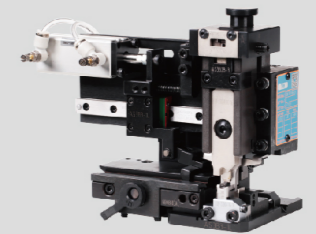

HACINT | 鹤壁海昌智能科技有限公司

自1994年成立以来，鹤壁海昌智能科技股份有限公司始终以“让智能制造触手可及”为企业使命，致力于做客户信赖的智能制造系统解决方案供应商。目前，公司实行3+2+X产品战略，主要产品包括：线束设备系列、压接模具系列、线束测试系列、智能软件系列、智能装备系列、线束行业专用设备系列，产品广泛应用于汽车、家电、5G、3C、医疗、电动工具、光伏、半导体等行业。

企业使命：让智能制造触手可及

企业愿景：做客户信赖的智能制造系统解决方案供应商

经营理念：以诚铸品 和谐共赢

研发理念：聚焦客户 孕育精品

质量方针：杰出 超出我们用户的期望

服务理念：真诚 周到 高效 专业



东莞海弘·华南研发中心



昆山海弘·华东研发中心



河南海弘·软件开发公司

合作伙伴 (部分)



全自动压接机



HBQ-802E 型全自动下线压接机



HBQ-804 型全自动下线压接机



HBQ-804H 型全自动下线压接机

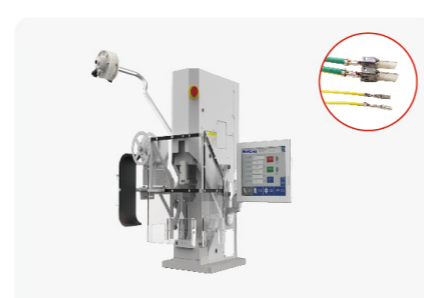

HBQ-160 多功能压接机 2.5T



HBQ-160H 型多功能压接机 8T



JSI/ESI 网络压接机 4T/8T



HBQ-804P 型全自动下线压接机



HBQ-805 型全自动下线压接机

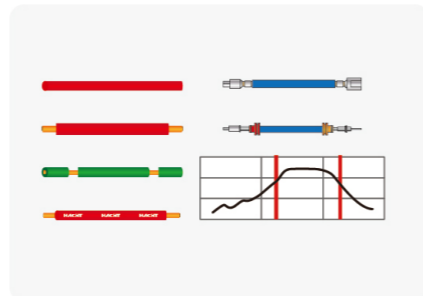

NJSI/NESI 网络伺服压接机 4T/8T



HBQ-P12 压接机 12T



HBQ-S18 伺服压接机 30T



HBQ-G501 全自动压接沾锡机



HBQ-G502 全自动中剥双头压接机

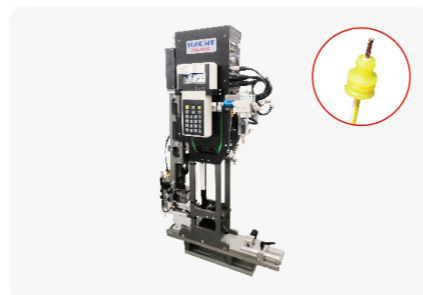

FSA-001E 型防水栓工作站



HBQ-H15A 油压机 15T



HBQ-125A 免换模压接机 25T



HBQ-K642 FPC端子柔性压接机



HBQ-804-03A 型预送线器

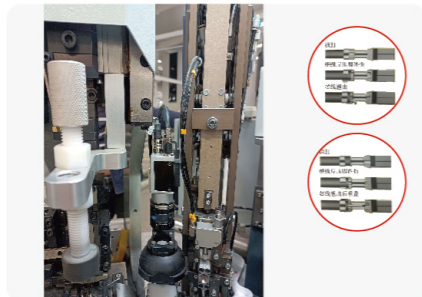

CVS-A30 端子检测系统

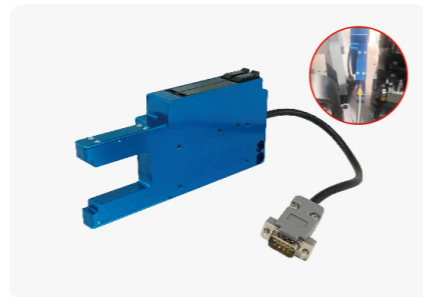

HBQ-054 剥皮及穿栓检测系统



HBQ-2030JB-FPC 压接机



压力管理装置 (CFM)



自动卷纸器

半自动压接机



HBQ-2030JB/X4030JB/8030J 型端子压接机



HBQ-2040EB/X4040EB/8040E 型端子压接机



HBQ-P20/P30 型压接机 20T/30T

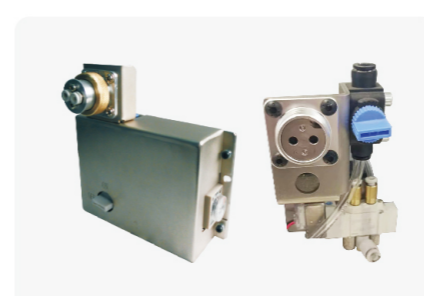

气动送料模块



闭合高度仪

剥打一体机



HBQ-208 同心剥打一体机



HBQ-210B 双线穿剥打一体机



HBQ-210C 双线剥打一体机



HBQ-210D 重型穿剥打一体机



HBQ-210E 三线穿剥打一体机



HBQ-210F 双线剥打一体机



HBQ-109 新能源双剥双打工作站



HBQ-212A 以太网短线剥皮压接设备

多功能设备



HBQ-902 多线型加工中心



HBQ-G512 全自动双头单线插壳机



HBQ-G515 全自动双头多线插壳机(第二代)



HBQ-903 控制柜线束加工中心



HBQ-922 双线绞合加工中心



HBQ-180B 智能大平线加工中心



新

HBQ-910-S FAKRA自动线



新

HBQ-910-H FAKRA自动线



HBQ-212 以太网自动加工线



HBQ-912 以太网自动加工线



新

HBQ-912 HMTD以太网自动线



新

HBQ-961 新能源线束加工柔性自动线



HBQ-428B 新能源线材处理自动线

剪剥设备 CUTTING AND STRIPPING EQUIPMENT



新

HBQ-433 高精度拉线裁线机



HBQ-041C 型自动导线剪剥机



HBQ-421 全自动屏蔽线下线机 Φ6-25mm



HBQ-423 全自动屏蔽线下线机 Φ2-12.5mm



HBQ-429 电动剥皮机 maxΦ6mm



HBQ-430 半自动同轴线剥线机 Φ0.5-8mm



HBQ-422A 型环剥机 Φ3-18mm



HBQ-426 型环剥机 Φ5-30mm



HBQ-425A 屏蔽网切割机



HBQ-373 新能源热缩管收缩机



HBQ-374A 焊接热缩一体机



HBQ-068 双头绞线机



HBQ-225B 新能源线束加工三合一设备



HBQ-224 新能源线束加工六合一设备



HBQ-068JD 双头点缠绞线机



HBQ-360 四头绞线机



HBQ-361 四头拉线绞线机

■ 防水密封设备



FSM-001 手动穿栓机



WPP 型防水栓模具



FSY-001 防水栓去油机



HBQ-362 四头点缠绞线机



HBQ-067 胶带捆扎机



HBQ-340 胶带点缠机



HBQ-Z209B 盲堵插入机



HBQ-Z215B 盲棒插入机



HBQ-320 扎带枪 W: 1.9-7.2mm



HBQ-321 扎带枪 W: 2.8-12.5mm



HBQ-Z211 卡扣安装设备

■ 线束后工序设备



HBQ-371 中间热缩管收缩机



HBQ-371DZ 热缩管对中装置



HBQ-372 端部热缩管收缩机



TLZ-4 两面落地回转式流水线



TLZ-5 两面轻轨回转式流水线



TLZ-6 两面横移翻转式流水线



TLZ-7 旋转流水线

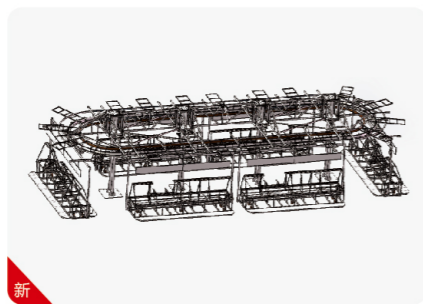

TLZ-8 悬挂式流水线



HBQ-G401B 力矩工作站 (视觉版)



HBQ-G420 压力工作站



HBQ-G420A 全自动压力工作站



HBQ-K637A 胶带裁切机

■ 超声波焊接设备



HBQ-K701 超声波线束焊接机



HBQ-K711 超声波端子焊接机

■ 光伏储能设备



HBQ-G102 光伏及储能连接器线束螺母拧紧机



HBQ-G203 光伏线裁铆宁一体机



HBQ-G205 光伏连接器自动组装机

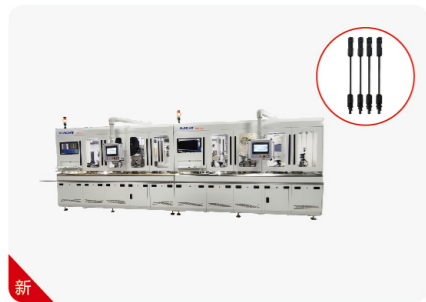

HBQ-G207 光伏线裁铆宁正负极一体机

■ 压接模具系列



YJM-AFS300I 型压接模具



YJM-AFE300I 型压接模具



S3D 型压接模具



GS3M2 欧式机械压接模具

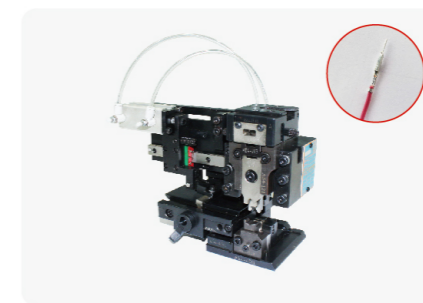

AS4A 型压接模具



AE4A 型压接模具



XS4 型压接模具



E4 型压接模具

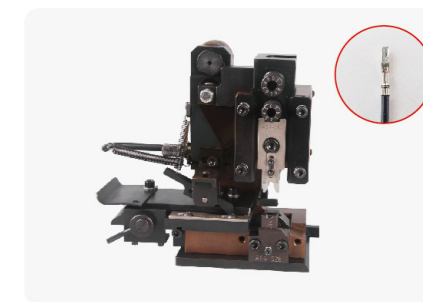

YJM-4XA 模具



YJM-100 模具



GS3M4 型韩式端子压接模具

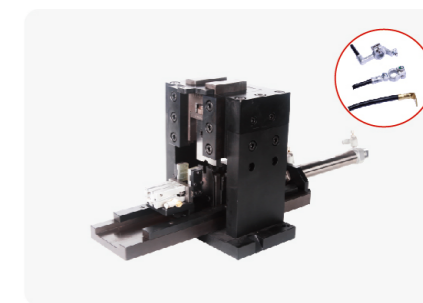

CLM 轻型电瓶端子压接模具



AFS300B-S 智能芯控压接模具



AFS300K 压接模具

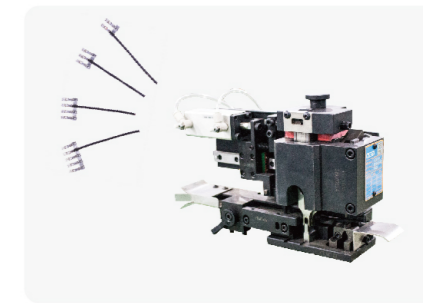

AFTCA 计数切断型压接模具

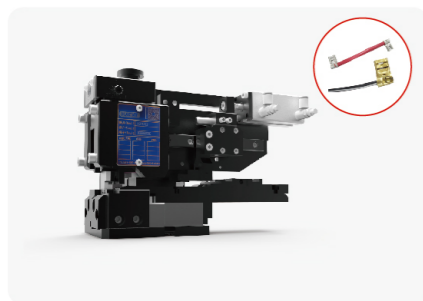

NEFTCA-X 型旗形端子压接模具

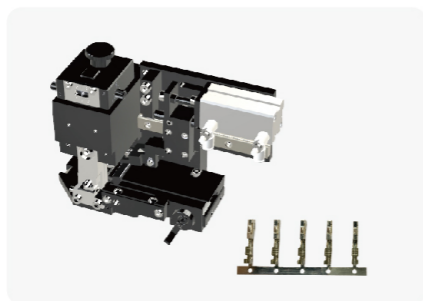

ADS 右进料压接模具

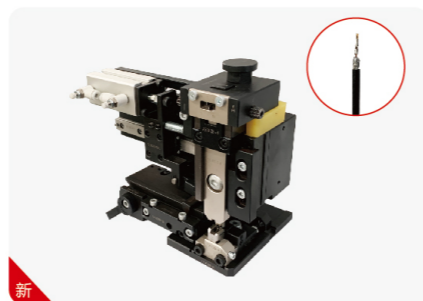

YJM-AFS300M 型压接模具

新

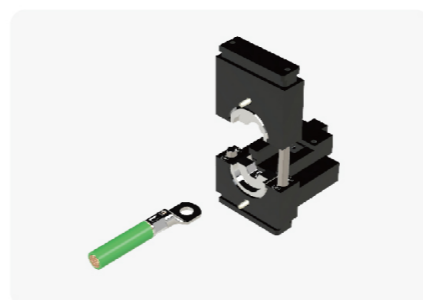

WHCA 压接模具



易损件 (压接刀具等)



ESTA 单粒端子压接模具解决方案



FPCA 四点压接模具



SPCA 六点压接模具

■ 线束测试系列



CS 型线束检测系统

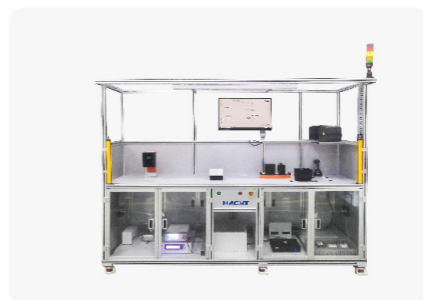

HCS6000 新能源线束高压检测台



CSA 卡钉检测台

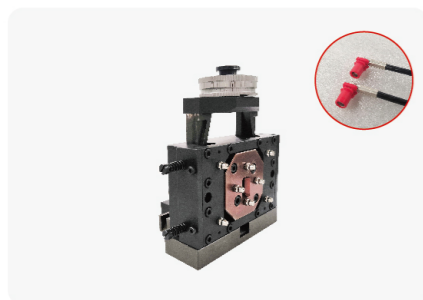

RFPCA 压接模具



EHCA 封闭式端子免换压接模具

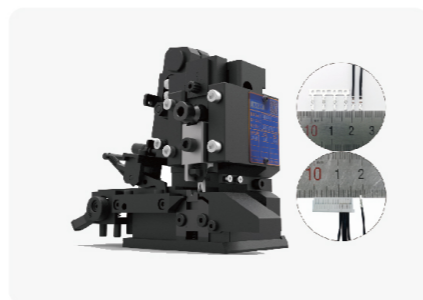

Nano 型压接模具 (S4B)



CSB 保险盒影像检测台



HBQ-G421 激光高度视觉检测台



HBQ-G422 视觉检测台

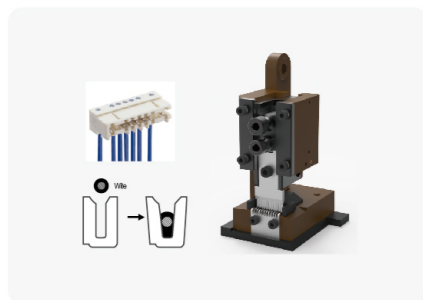

DYM-C 刺破压接模具

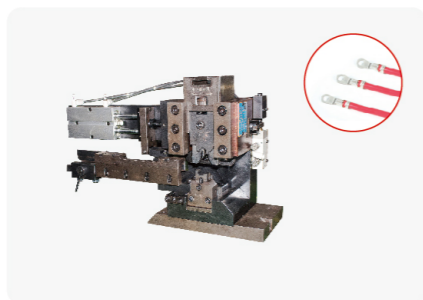

LCMS 型重载压接模具



HCA 封闭式端子免换模压接模具



CSB-TXF100 FAKRA线束同轴度视觉检测导通台



GZ-0012 气密导通检测台



HBQ-350 端子剖面分析仪

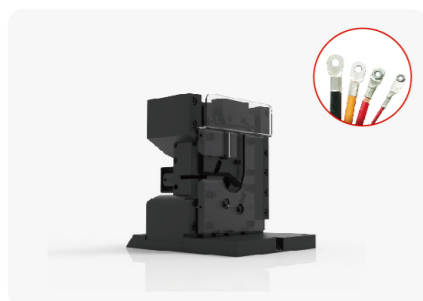

NHCA 封闭式端子免换模压接模具



HSPCA 压接模具

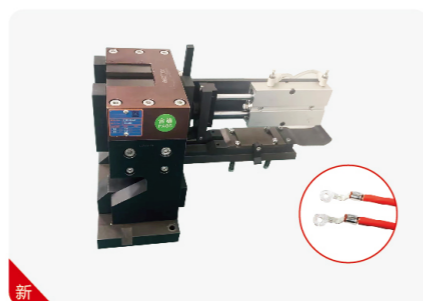

LCME 型压接模具

新



HBQ-052A 型端子剖面工作室



HBQ-053 型端子剖面工作室



HBQ-061C/064/065/065-E 型数字拉力试验机



HBQ-411 型数字拉力试验机



HBQ-412 万牛卧式拉力试验机



HBQ-413 检验工作站



HBQ-401 型扎带枪拉力试验机

测试模块



气密模块



PUSH BACK模块



外凸锁片关闭模块

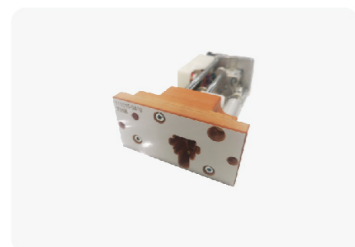

USB专用模块



40路针以上ECU模块



卧式结构模块

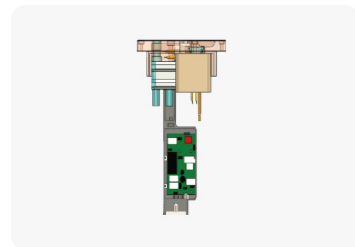

内凹锁片关闭模块

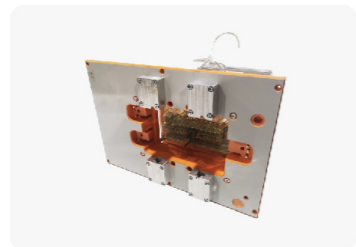

保险丝盒模块

智能装备系列

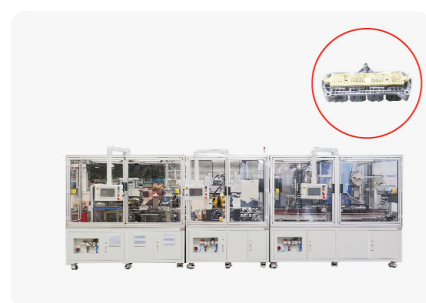

HBQ-K612 168W板端连接器设备

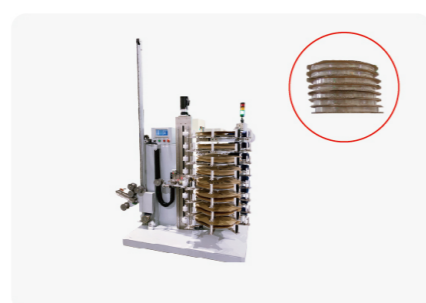

HBQ-Z108 8盘卧式端子收料机

线束行业外设备系列

新能源线解决方案

新能源压接设备



HBQ-P20/P30 型压接机



HBQ-P12 压接机



HBQ-S18 伺服压接机



HBQ-H15A 油压机



HBQ-125A 免换模压接机

新能源压接模具



FPCA 四点压接模具



SPCA 六点压接模具



EHCA 闭式端子免换压接模具



HCA 闭式端子免换模压接模具

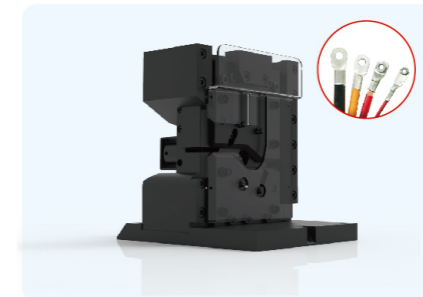

NHCA 闭式端子免换模压接模具

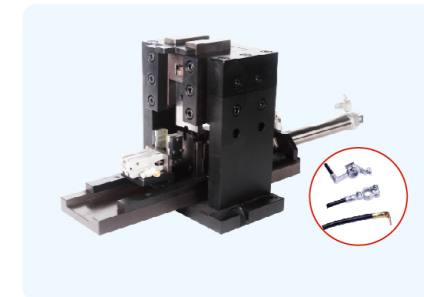

CLM 轻型电瓶端子压接模具

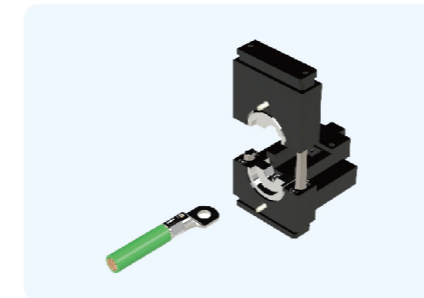

WHCA 压接模具

■ 新能源超声波焊接设备



HBQ-K701 超声波线束焊接机



HBQ-K711 超声波端子焊接机

■ 新能源剪剥设备



HBQ-421 全自动屏蔽线下线机



HBQ-423 全自动屏蔽线下线机

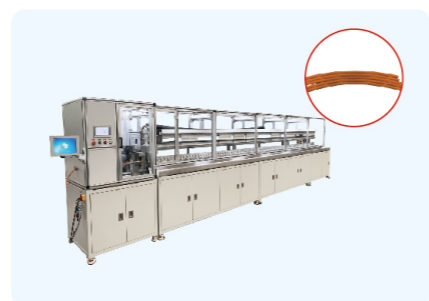

HBQ-433 高精度拉线裁线机



HBQ-422A 型环剥机



HBQ-425A 屏蔽网切割机



HBQ-426 型环剥机

■ 新能源后工序设备



HBQ-373 新能源热缩管收缩机



HBQ-Z211 卡扣安装设备



HBQ-G420 压力工作站



HBQ-G420A 全自动压力工作站

■ 新能源检测设备



HCS6000 新能源线束高压检测台



HBQ-G422 视觉检测台



GZ-0012 气密导通检测台



HBQ-411 型数字拉力试验机



HBQ-412 万牛卧式拉力试验机

■ 新能源多工序集成设备



HBQ-109 新能源双剥双打工作站



HBQ-P20Z 专用连续压接机



HBQ-126 屏蔽环工作站



HBQ-225B 新能源线束加工三合一设备



HBQ-224 新能源线束加工六合一设备



HBQ-428B 新能源线材处理自动线



HBQ-961 新能源线束加工柔性自动线

射频线、视频线和以太网线解决方案

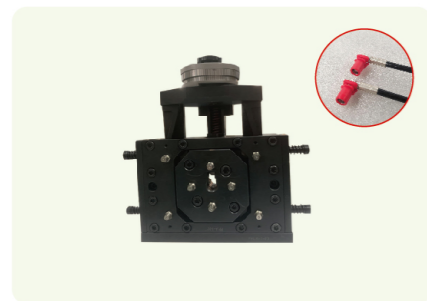

RFPCA 压接模具



HBQ-430 半自动同轴线剥线机



HBQ-041C 型自动导线剪剥机



HBQ-210C 双线剥打一体机



HBQ-212 以太网自动加工线



HBQ-212A 以太网短线剥皮压接设备



HBQ-912 以太网自动加工线

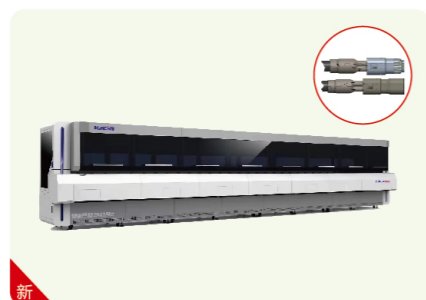

HBQ-912 HMTD以太网自动线



CSB-TXF100 FAKRA线束同轴度视觉检测导通台



HBQ-910B FAKRA线束连接器自动组装机

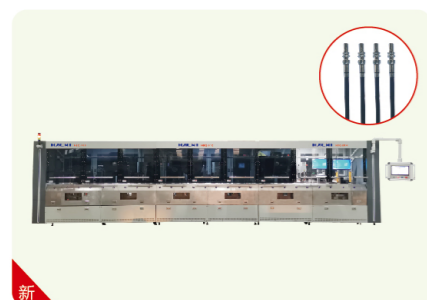

HBQ-910-S FAKRA自动线

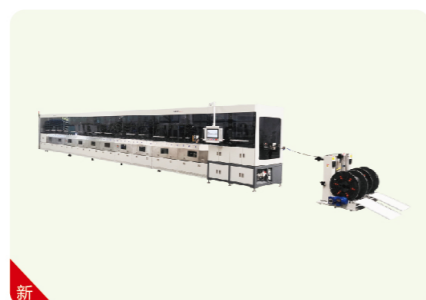

HBQ-910-H FAKRA自动线



光伏储能解决方案



HBQ-G102 光伏及储能连接器线束螺母拧紧机



HBQ-G203 光伏线裁铆一体机



HBQ-G205 光伏连接器自动组装机



HBQ-G207 光伏线裁铆正负极一体机



HBQ-G420 压力工作站

智能软件解决方案

海弘智造信息系统 HMES

专注行业

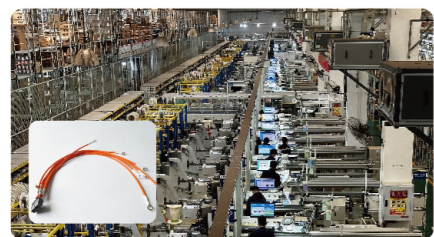

线束



注塑

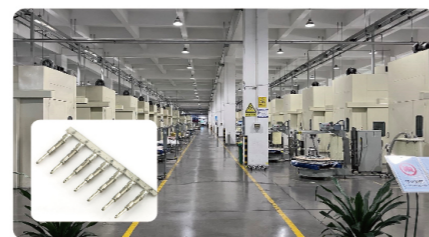

冲压



线缆



机加



电子

功能

设备管理

设备台账, 点检维修, 数据采集

模具管理

出入库履历, 保养提醒, 模具台账

工艺管理

工艺Bom, 工艺流程, 工艺参数

生产管理

订单排程, 任务分配, 进度监控

安灯管理

问题反馈, 升级提醒, 统计分析

质量管理

检验项目, 检验记录, 返修处理

集成管理

ERP集成, WMS集成, 设备集成

报表管理

生产报表, 异常报表, 质检报表

系统特点

● 排产智能化

工序平衡 资源优化 精益制造

● 全流程追溯

原料追溯 产品追溯 质量追溯

● 多端协同化

快速扩展 高效协同 操作快捷

● 系统集成化

实时通信 模块融合 数据共享

● 采集自动化

实时获取 状态监控 数据透明

● 报表可视化

直观展示 多维分析 动态交互



扫码输入设备型号
获取详细信息



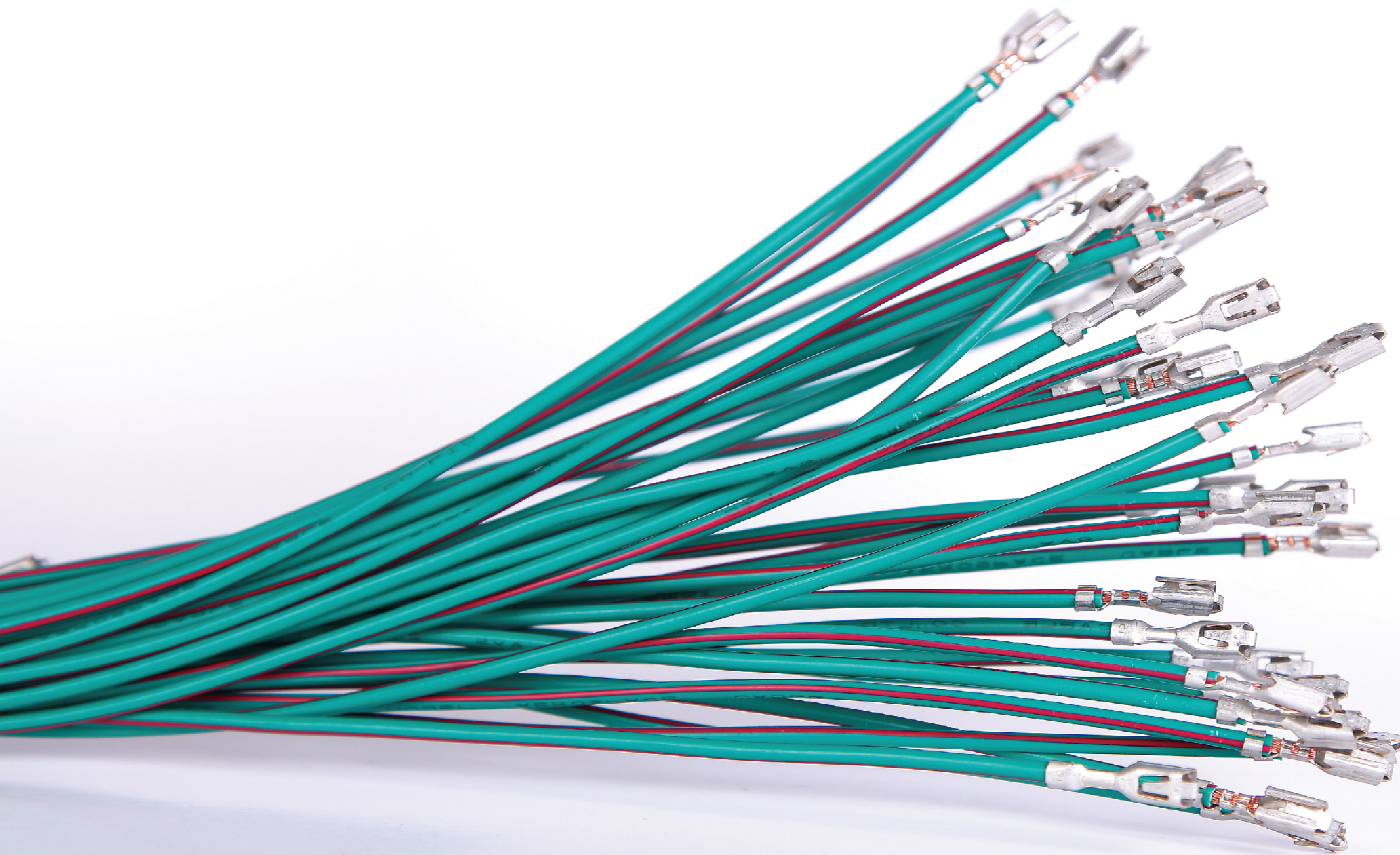

HACNT

杰出，超出客户的期望